



**HELLENIC GAS  
TRANSMISSION  
SYSTEM OPERATOR**

357-359, MESSOGION AVE.,  
15231 ATHENS, GREECE  
Tel.: 210 6501258  
Fax : 210 6501551

**TECHNICAL JOB  
SPECIFICATION**

**610/2**

**REVISION 0**

**DATE 29/06/2011**

# **LNG PLANT**

## **INSTRUMENTATION SYMBOLS AND IDENTIFICATION**

**Job Spec. No** 610/2  
**Revision** 0  
**Date** 29-06-2011  
**Page** 2/27

**QUALITY ASSURANCE PAGE**
**CHANGES LOG**
**REVISIONS LOG**

<b>0</b>	<b>29-06-2011</b>	<b>FIRST ISSUE</b>	<b>PQ DPT.</b>	<b>V.G.</b>
Rev. No	Rev. Date	REASON FOR CHANGE	Made By	Approved By

Job Spec. No 610/2  
Revision 0  
Date 29-06-2011  
Page 3/27

CONTENTS

REFERENCED DOCUMENTS

- 1.0 GENERAL
- 2.0 FUNCTIONAL IDENTIFICATION
- 3.0 LOOP IDENTIFICATION
- 4.0 SYMBOLS
- 5.0 ATTACHED DOCUMENTS

Job Spec. No 610/2  
Revision 0  
Date 29-06-2011  
Page 4/27

**REFERENCED DOCUMENTS**

1. **ISA S5.1 (1984)**  
[Instrumentation Symbols and Identification]
2. **ISA S5.3(1983)**  
[Graphic Symbols for Distributed Control / Shared Display Instrumentation  
Logic and Computer Systems]

Job Spec. No 610/2  
Revision 0  
Date 29-06-2011  
Page 5/27

## 1.0 GENERAL

Instruments shall be identified by a system of letters and numbers generally in accordance with **the Instrument Society of America (ISA) Standards S5.1, and S5.3** last edition, extracts from which follow. Minor modifications have been made, in this specification.

Each instrument will be identified first by a system of letters used to classify it functionally. (See **Tables 1 and 2** for the system of letters). To establish a loop identity for the instrument, a number will be appended to the letters. This number will, in general, be common to other instruments of the loop of which this instrument is a part. A suffix is sometimes added to complete the loop identification.

Where **ISA Standards S5.1 and S5.3** offer alternate methods of presentation, Owner practice is to use the method requiring the fewest symbols.

Symbols will not be shown for the following:

- a) Valve positioners.
- b) Field mounted I/P transducers, when no solenoid valve or other device is in line between I/P and valve.
- c) Balloons identifying flow and temperature primary elements.
- d) Multiplexing, when used for panel mounted temperature indication only.
- e) Local process variable indicators on transmitter outputs, unless it is intended to designate a special location for the indicator, as shown by a note next to the tagging balloon.

## 2.0 FUNCTIONAL IDENTIFICATION

The functional identification of an instrument will consist of letters from **Table 1**, and will include on first-letter, covering the measured or initiating variable, and one or more succeeding letters covering the functions of the individual instrument. Exceptions to this rule are the use of the single letter L to denote a pilot light that is not part of an instrument loop and certain computer functions which will use modifying letters only.

The succeeding-letters of the functional identification designate one or more readout or passive functions, or output functions, or both. A modifying-letter may be used, if required, in addition to one or more other succeeding-letters. Modifying letters may modify either a first-letter or other succeeding-letters, as applicable. All letters of the functional identification shall be upper case. For examples of combinations of functional identification letters, see **Table 2**.

The functional designation associated with relays and computers may be used, as shown in **Table 3**, individually or in combination. The use of a box enclosing a symbol is required. The box is intended to avoid confusion by setting off the symbol from other markings on a diagram.

Job Spec. No 610/2  
Revision 0  
Date 29-06-2011  
Page 6/27

**TABLE 1**  
**IDENTIFICATION LETTERS**

	FIRST - LETTER (2.3.2)		SUCCEEDING - LETTERS		
	MEASURED OR INITIATING VARIABLE	MODIFIER	READOUT OR PASSIVE FUNCTION	OUTPUT FUNCTION	MODIFIER
A	Analysis (2.3.4)		Alarm		
B	Burner, Combustion		User's Choice (2.3.1)	User's Choice (2.3.1)	User's Choice (2.3.1)
C	Heating Value			Control	
D	Density	Differential (2.3.2)			
E	Voltage		Sensor (Primary Element)		
F	Flow Rate	Ratio (Fraction) (2.3.2)			
G	User's Choice (2.3.1)		Glass, Viewing Device		
H	Hand				High
I	Current (Electrical)		Indicate		
J	Power	Scan			
K	Time, Time Schedule	Time Rate of Change (2.3.2., 2.3.7)		Control Station (2.3.7)	
L	Level		Light (2.3.5)		Low
M	Energy	Momentary (2.3.2)			Middle Intermediate
N	User's Choice (2.3.1)		User's Choice (2.3.1)	User's Choice (2.3.1)	User's Choice (2.3.1)
O	User's Choice (2.3.1)		Orifice, Restriction		
P	Pressure, Vacuum		Point (Test)Connection		
Q	Quantity	Integrate, Totalize (2.3.2)			
R	Radiation		Record		
S	Speed, Frequency	Safety		Switch	
T	Temperature			Transmit	
U	Multivariable (2.3.8)		Multifunction (2.3.9)	Multifunction (2.3.9)	Multifunction (2.3.9)
V	Vibration, Mechanical Analysis			Valve, Damper, Louver	
W	Weight, Force		Well		
X	Unclassified (2.3.3)	X Axis	Unclassified (2.3.3)	Unclassified (2.3.3)	Unclassified (2.3.3)
Y	Event, State or Presence	Y Axis		Relay, Compute Convert	
Z	Position, Dimension	Z Axis		Driver, Actuator, Unclassified Final Control Element	

Job Spec. No 610/2  
Revision 0  
Date 29-06-2011  
Page 7/27

## 2.1 Notes For Table 1 - Meaning of Identification Letters

A user's choice letter is intended to cover unlisted meanings that will be used repetitively in a particular project. If used, the letter may have one meaning as a first-letter and another meaning as a succeeding-letter. For example, the letter N may be defined as "modulus of elasticity" as a first-letter and "oscilloscope" as a succeeding-letter.

Any first-letter, if used in combination with modifying letters D (differential or deviation), F (ratio), M (momentary), K (time rate of change), Q (integrate or totalize), or any combination of these is intended to represent a new and separate measured variable, and the combination is treated as a first-letter entity. Thus, instruments TDI and TI indicate two different variables, namely, differential- temperature and temperature. Modifying letters are used when applicable.

The unclassified letter X is intended to cover unlisted meanings that will be used only once or to a limited extent. If used, the letter may have any number of meanings as a first-letter and any number of meanings as a succeeding - letter. Except for its use with distinctive symbols, it is expected that the meanings will be defined outside a tagging balloon on a flow diagram. For example, XR-2 may be a stress recorder, XR-3 may be a vibration recorder, and XX-4 may be a stress oscilloscope.

First-letter A for analysis covers all analyses that are not listed in TABLE 1 and are not covered by a user's choice letter. It is expected that the type of analysis in each instance will be defined outside a tagging balloon on a flow diagram.

A pilot light that is part of an instrument loop should be designated by a first-letter followed by the succeeding- letter L. For example, a pilot light that indicates an expired time period should be tagged KQL. If it is desired to tag a pilot light that is not part of an instrument loop, the light is designated in the same way. For example, a running light for an electric motor may be tagged EL, assuming voltage to be appropriate measured variable, or YL, assuming the operating status is being monitored. The unclassified variable X should be used only for applications which are limited in extent. The designation XL should not be used for motor running lights, as these are commonly numerous. It is permissible to use the user's choice letters M, N or O for a motor running light when the meaning is previously defined. If M is used, it must be clear that the letter does not stand for the word "motor", but for a monitored state.

If a given loop has more than one instrument with the same functional identification, then a suffix shall be appended to the loop number, e.g. FV- 2A,FV-2B,etc., or TE-25-1, TE-25-2, etc.

However, if digital systems are involved, the use of suffixes may not be compatible and unique consecutive numbers shall be used. In such cases, using flow as an example, the main instrument should take the number of the Primary Case, e.g. with High and Low Flow arrangement, the transmitters shall be numbered, say FT-2 and FT-3, while the main instrument would be numbered FRC-2.

Modifying-letter K, in combination with a first-letter such as L, T, or W, signifies a time rate of change of the measured or initiating variable. The variable WKIC, for instance, may represent a rate-of- weight-loss controller.

**Job Spec. No** 610/2  
**Revision** 0  
**Date** 29-06-2011  
**Page** 8/27

Succeeding-letter K is a user's option for designating a control station, while the succeeding-letter C is used for describing automatic or manual controllers.

Use of first-letter U for "multivariable" in lieu of a combination of first-letters is optional. It is recommended that nonspecific variable designators such as U be used sparingly.

Use of a succeeding-letter U for "multifunction" instead of a combination of other functional letters is optional.

This non-specific function designator should be used sparingly.



Job Spec. No 610/2  
Revision 0  
Date 29-06-2011  
Page 9/27

**TABLE 2**  
**TYPICAL LETTER COMBINATIONS**

INSTRUMENT FUNCTION	MEASURED VARIABLE									
	ANALYSIS	DENSITY	FLOW	LEVEL	PRESSURE	PRESSURE DIFFERENTIAL	SPEED	TEMPERATURE	TEMPERATURE DIFFERENCE	
ELEMENT INDICATOR TRANSMITTER RECORDER CONTROLLER INDICATING CONTROLLER RECORDING CONTROLLER CONTROL VALVE CONTROL VALVE--SELF ACTING SWITCH--LOW SWITCH--HIGH ALARM--LOW ALARM--HIGH SOLENOID VALVE	AE AI AT AR AC AIC ARC AV - ASL ASH AAL AAH AY	DE DI DT DR DC DIC DRC DV - DSL DSH DAL DAH DY	FE FI FT FR FC FIC FRC FV - FSL FSH FAL FAH FY	LE LI LT LR LC LIC LRC LV LCV LSL LSH LAL LAH LY	PE PI PT PR PC PIC PRC PV PCV PSL PSH PAL PAH PY	PDE PDI POT POR POC PDC PDR PDRC PDV PDCV PDSL PDSH PDAL PDAH PDY	SE SI ST SR SC SIC SRC SV - SSL SSH SAL SAH SY	TE TI TT TR TC TIC TRC TV TCV TSL TSH TAL TAH TY	TDE TDI TOT TDR TDC TDC TDC TDC TDV - TDSL TDSH TDAL TDAH TDY	
BE BS CE EI EL FG FO FOI FQIS FY HV HIC HS HLS HIK LG PSE PRV ZSL ZSH ZLL ZLH UR W	BURNER FLAME DETECTOR FLAME DETECTION SWITCH ELECTRICAL CONDUCTIVITY PROBE VOLTAGE INDICATOR INDICATION LIGHT FLOW SIGH GLASS (FLAPPER, ETC.) FLOW RESTRICTION ORIFICE INDICATION OF INTEGRATED FLOW INDICATION OF INTEGRATED FLOW AND SWITH ACTUATED BY INTEGRATED FLOW FLOW RELAY (EG. RATIO, LINEARIZING) HAND CONTROL VALVE MANUAL LOADING STATION WITH OUTPUT GAUGE HAND SWITCH HAND SWITCH WITH INDICATING LIGHT MANUAL LOADING STATION WITH OUTPUT GAUGE AND PROCESS INDICATION LEVEL GAUGE RUPTURE DISC RELIEF VALVE POSITION SWITCH (LOW OR CLOSED) POSITION SWITCH (HIGH OR OPEN) LIGHT IND. LOW OR CLOSED POSITION LIGHT IND. HIGH OR OPEN POSITION TREND RECORDER MULTIPLEXING UNIT, WHEN USED FOR GENERAL DATA ACQUISITION									











Job Spec. No 610/2  
Revision 0  
Date 29-06-2011  
Page 10/27

TABLE 3  
DESIGNATION FOR RELAYS AND COMPUTER FUNCTIONS

NO	FUNCTION	SYMBOL	DEFINITION
1	SUMMING	$\Sigma$	THE OUTPUT EQUALS THE ALGEBRAIC SUM OF THE INPUTS. (THE INPUTS MAY BE LABELED WITH POSITIVE OR NEGATIVE SIGNS).
2	AVERAGING	$\Sigma/n$	THE OUTPUT EQUALS THE ALGEBRAIC SUM OF THE INPUTS DIVIDED BY THE NUMBER OF INPUTS.
3	DIFFERENCE	$\Delta$	THE OUTPUT EQUALS THE ALGEBRAIC DIFFERENCE OF THE TWO INPUTS.
4	PROPORTIONAL	$K$ 1:1 2:1	THE OUTPUT IS DIRECTLY PROPORTIONAL TO THE INPUT. IN THE CASE OF A VOLUME BOOSTER, "K" MAY BE REPLACED BY 1:1. FOR INTEGER GAINS, 2:1, 3:1, ETC., MAY BE SUBSTITUTED FOR K.
5	INTEGRAL	$\int$	THE OUTPUT VARIES IN ACCORDANCE WITH BOTH MAGNITUDE AND DURATION OF THE INPUT. THE OUTPUT IS PROPORTIONAL TO THE TIME INTEGRAL OF THE INPUT.
6	DERIVATIVE	$d/dt$	THE OUTPUT IS PROPORTIONAL TO THE RATE OF CHANGE (DERIVATIVE) OF THE INPUT.
7	MULTIPLYING	$\times$	THE OUTPUT EQUALS THE PRODUCT OF THE TWO INPUTS.
8	DIVIDING	$\div$	THE OUTPUT EQUALS THE QUOTIENT OF THE TWO INPUTS.
9	ROOT EXTRACTION	$\sqrt[n]{\quad}$	THE OUTPUT EQUALS THE ROOT (I.E., CUBE ROOT, FOURTH ROOT, 3/2 ROOT, ETC.) OF THE INPUT. IF n IS OMITTED, A SQUARE ROOT IS ASSUMED.
10	EXPONENTIAL	$x^n$	THE OUTPUT EQUALS THE INPUT RAISED TO A POWER (I.E., SECOND, THIRD, FOURTH, ETC.).
11	NONLINEAR OR UNSPECIFIED FUNCTION	$f(x)$	THE OUTPUT EQUALS SOME NONLINEAR OR UNSPECIFIED FUNCTION OF THE INPUT.
12	TIME FUNCTION	$f(t)$	THE OUTPUT EQUALS THE INPUT TIMES SOME FUNCTION OF TIME OR EQUALS SOME FUNCTION OF TIME ALONE.

Job Spec. No 610/2  
Revision 0  
Date 29-06-2011  
Page 11/27

TABLE 3 (Contd.)

NO	FUNCTION	SYMBOL	DEFINITION
13	HIGH SELECTING		THE OUTPUT IS EQUAL TO THE GREATER OF THE INPUTS.
14	LOW SELECTING		THE OUTPUT IS EQUAL TO THE LESSER OF THE INPUTS.
15	HIGH LIMITING		THE OUTPUT EQUALS THE INPUT OR THE HIGH LIMIT VALUE WHICHEVER IS LOWER.
16	LOW LIMITING		THE OUTPUT EQUALS THE INPUT OR THE LOW LIMIT VALUE WHICHEVER IS HIGHER.
17	REVERSE PROPORTIONAL		THE OUTPUT IS REVERSELY PROPORTIONAL TO THE INPUT.
18	VELOCITY LIMITER		THE OUTPUT EQUALS THE INPUT AS LONG AS THE RATE OF CHANGE OF THE INPUT DOES NOT EXCEED A LIMIT VALUE. THE OUTPUT WILL CHANGE AT THE RATE ESTABLISHED BY THIS LIMIT UNTIL THE OUTPUT AGAIN EQUALS THE INPUT.
19	BIAS		THE OUTPUT EQUALS THE INPUT PLUS (OR MINUS) SOME ARBITRARY VALUE (BIAS).
20	CONVERT		THE FORM OF THE OUTPUT SIGNAL IS DIFFERENT FROM THAT OF THE INPUT. * - VOLTAGE                      A - ANALOG                      O - ELECTROMAGNETIC, SONIC † - CURRENT                      B - BINARY                      R - RESISTANCE (ELECT.) P - PNEUMATIC                      H - HYDRAULIC                      D - DIGITAL
21	SIGNAL MONITOR		THE OUTPUT HAS DISCRETE STATES WHICH ARE DEPENDENT ON THE VALUE OF THE INPUT. WHEN THE INPUT EXCEEDS (OR BECOMES LESS THAN) AN ARBITRARY LIMIT VALUE THE OUTPUT CHANGES STATE.
			
			

Job Spec. No 610/2  
Revision 0  
Date 29-06-2011  
Page 12/27

### 3.0 LOOP IDENTIFICATION

The loop identification of an instrument will generally use a number assigned to the loop of which the instrument is a part. Each instrument loop shall have a unique number. An instrument common to two or more loops may have a separate loop number, if desired.

A consecutive numbering of instruments shall be used for each process variable of a contract. The loop numbering sequence for each process variable will begin with the number 001 and run consecutively until all loops in a given contract/process unit are identified.

It is Owner practice to assign a new contract number to each section of a multi-section job. Therefore, to discriminate between such sections, the functional identification letters will be followed by two digits of the process unit number, as follows:

<b>FIC</b>	<b>29</b>	<b>001</b>
<b>Functional</b>	<b>Unit</b>	<b>Progressive number</b>
<b>Identification</b>	<b>Number</b>	

### 4.0 SYMBOLS

It is not the intention of this standard to list all symbols or combinations. **ISA Standards S5.1 and S5.3** list many more.

Control valve positioners and control valve electric-to-air converters will not be shown. Therefore, with an electrical system, the controller output (electrical) signal will be schematically shown connected to the valve diaphragm, while the actual installation will have a converter.

Various expedients may be used on individual contracts. For example, the letter "V" just outside the circle can indicate an item supplied by a Package Vendor.

The actuator action in the event of actuating medium failure shall be shown on control valves (see typical control valve symbols).

Software alarms shall follow **ISA Standards sections 5.1 and 5.3**. Letter designators shall be placed on the input or output signal lines of controls or other specific system function.

When dual pen instruments are shown on different flow diagrams, a note can show "To second pen on TR-101" or the tangential circle can be shown in phantom as follows:

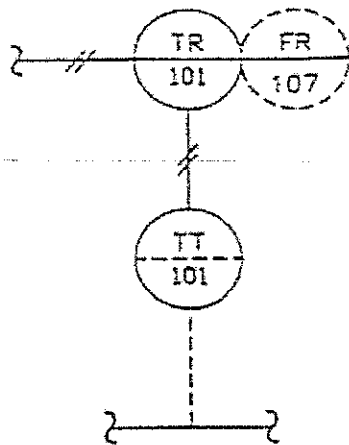

P/I DIAGRAM No.1

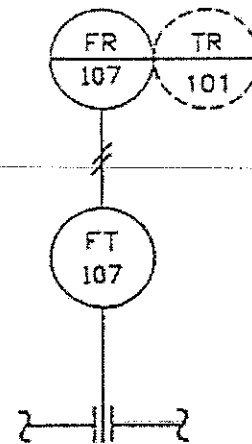

P/I DIAGRAM No.2

Computer functions will be shown as a hexagon. Use modifying letters only since the measured variable "UJ" is implied by the hexagon.

The symbols used to depict instrumentation on flow diagrams and other drawings are shown on **Appendix 1**.







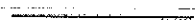
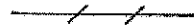

5.0

**ATTACHED DOCUMENTS**



1. **Appendix 1**  
[Instrument Symbols]

APPENDIX 1

INSTRUMENT LINE SYMBOLS

	CONNECTION TO PROCESS	(Note 1)
	UNDEFINED SIGNAL	
	PNEUMATIC SIGNAL	(Note 2)
	ELECTRIC SIGNAL	
	HYDRAULIC SIGNAL	
	CAPILLARY TUBING (FILLED SYSTEM)	
	ELECTROMAGNETIC (NUCLEAR) OR SONIC SIGNAL (GUIDED)	(Note 3)
	ELECTROMAGNETIC OR SONIC SIGNAL (NOT GUIDED)	(Note 3)
	INTERNAL SYSTEM LINK (SOFTWARE OR DATA LINK)	
	MECHANICAL LINK	













OPTIONAL BINARY (ON-OFF) SYMBOLS



	PNEUMATIC BINARY SIGNAL
	ELECTRIC BINARY SIGNAL

Notes :

1. All lines to be fine in relation to process piping lines.
2. The pneumatic signal symbol applies to a signal using any gas as the signal medium. If a gas other than air is used, the gas may be identified by a note on the signal symbol or otherwise.
3. Electromagnetic phenomena include heat, radio waves, nuclear radiation, and light.









GENERAL INSTRUMENT OR FUNCTION SYMBOLS

	PRIMARY LOCATION *** NORMALLY ACCESSIBLE TO OPERATOR	FIELD MOUNTED	AUXILIARY LOCATION *** NORMALLY ACCESSIBLE TO OPERATOR
DISCRETE INSTRUMENTS	1 * IP1** 	2 	3 
SHARED DISPLAY, SHARED CONTROL	4 	5 	6 
COMPUTER FUNCTION	7 	8 	9 
PROGRAMMABLE LOGIC CONTROL	10 	11 	12 

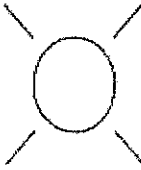
- \* Symbol size may vary according to the user's needs and the type of document . A suggested square and circle size for large diagrams is shown above. Consistency is recommended.
- \*\* Abbreviations of the user's choice such as IP1 (Instrument Panel #1 ), IC2 (Instrument Console #2 ), CC3 ( Computer Console #3) etc., may be used when it is necessary to specify instrument or function location.
- \*\*\* Normally inaccessible or behind-the-panel devices or functions may be depicted by using the same symbols but with dashed horizontal bars. i.e.   









Job Spec. No 610/2  
 Revision 0  
 Date 29-06-2011  
 Page 16/27

GENERAL INSTRUMENT OR FUNCTION SYMBOLS (Contd.)





<p>13</p>  <p>REPORT ON PRINTER</p>	<p>14</p>  <p>INSTRUMENT WITH LONG TAG NUMBER</p>	<p>15</p>  <p>INSTRUMENTS SHARING COMMON HOUSING</p>
<p>16</p>  <p>PILOT LIGHT</p>	<p>17</p>  <p>PANEL MOUNTED PATCHBOARD POINT 12</p>	<p>18</p>  <p>PURGE OR FLUSHING DEVICE</p>
<p>19</p>  <p>RESET FOR LATCH-TYPE ACTUATOR</p>	<p>20</p>  <p>DIAPHRAGM SEAL</p>	<p>21</p>  <p>UNDEFIND INTERLOCK LOGIC</p>









CONTROL VALVE BODY SYMBOLS, DAMPER SYMBOLS

 GENERAL SYMBOL	 ANGLE	 BUTTERFLY	 ROTARY VALVE
 THREE-WAY	 FOUR-WAY	 GLOBE	 DAMPER OR LOUVER

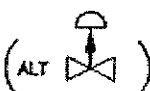
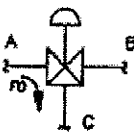



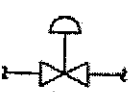

ACTUATOR SYMBOLS

 DIAPHRAGM TYPE ACTUATOR	 PISTON TYPE ACTUATOR	 MOTOR ACTUATOR	 SOLENOID ACTUATOR
--	---	---	--



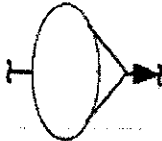
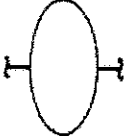

TYPICAL CONTROL VALVE SYMBOLS

 2-WAY VALVE--FAIL OPEN	 (ALT)	 3-WAY VALVE, FAIL OPEN TO PATH A-C
 2-WAY VALVE--FAIL CLOSED	 (ALT)	 DIAPHRAGM OPERATED VALVE WITH SIDE MOUNTED HANDWHEEL (OR TOP MOUNTED)
 2-WAY VALVE--FAIL LOCKED	 (ALT)	 HAND CONTROL VALVE IN PROCESS LINE

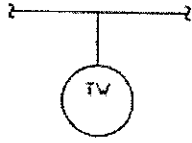
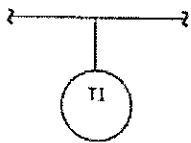
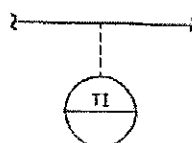
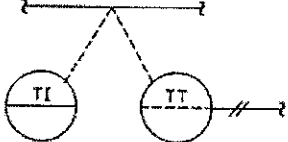
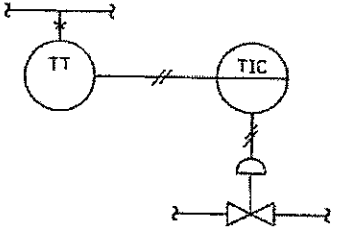
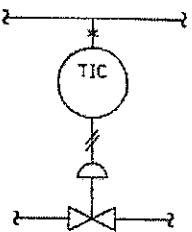
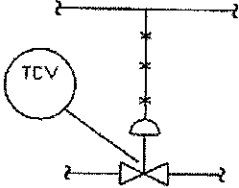
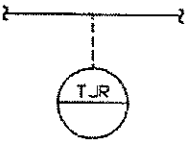
PRIMARY ELEMENT SYMBOLS

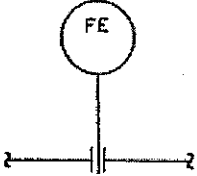
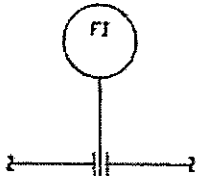
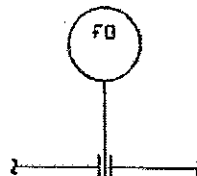
			
<p>ORIFICE PRIMARY ELEMENT</p>	<p>PITOT-TUBE OR ANNUBAR</p>	<p>VENTURI TUBE OR FLOW NOZZLE</p>	<p>ROTAMETER TYPE FLOW METER</p>
			
<p>LINE TYPE FLOW METER</p>	<p>VORTEX FLOW METER</p>	<p>TURBINE METER</p>	<p>POSITIVE DISPLACEMENT-TYPE FLOW TOTALIZING INDICATOR</p>

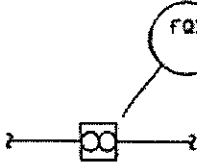
		
<p>TEMPERATURE TEST CONNECTION WITH WELL</p>	<p>LOCAL TEMPERATURE INDICATOR</p>	<p>BOARD MOUNTED TEMPERATURE INDICATOR (CAN ALSO BE USED WHEN TEMPERATURES ARE MULTIPLEXED TO BOARD MOUNTED DISPLAY)</p>
		
<p>DUPLEX THERMOCOUPLE CONNECTED TO REAR BOARD MTD. TRANSMITTER AND CHECKING INDICATOR</p>	<p>FILLED SYSTEM TYPE TRANSMITTER AND INDICATING CONTROLLER</p>	<p>FILLED SYSTEM TYPE LOCALLY MOUNTED INDICATING CONTROLLER</p>
		
<p>SELF ACTUATED TEMPERATURE CONTROL VALVE</p>	<p>THERMOCOUPLE OR RESISTANCE BULB CONNECTED TO MULTIPOINT RECORDER</p>	

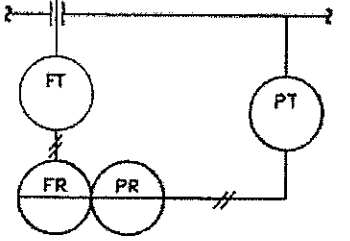
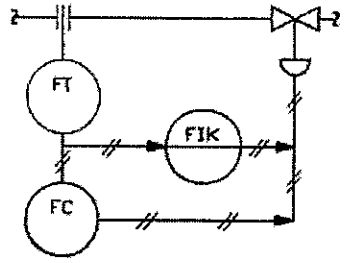
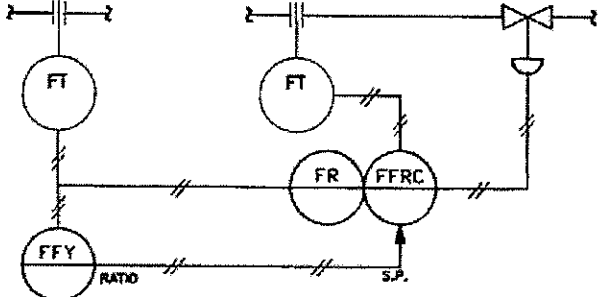
		
<p>FLOW ELEMENT. NO MEASURING INSTRUMENT PROVIDED</p>	<p>ORIFICE TYPE LOCAL FLOW INDICATOR</p>	<p>RESTRICTION ORIFICE (NO METER RUN REQUIRED)</p>
		
<p>FLOW SIGHT GLASS</p>	<p>ROTAMETER TYPE FLOW INDICATOR</p>	<p>POSITIVE DISPLACEMENT TYPICAL FLOW TOTALIZING INDICATOR</p>
		
<p>INLINE TYPE FLOW METER. IDENTIFY OUTSIDE BALLOON ( EG, INTEGRAL ORIFICE )</p>	<p>COMBINED FLOW/PRESSURE RECORDER WITH LOCAL TRANSMITTER FOR EACH PEN</p>	<p>FLOW CONTROL STATION WITH LOCAL CONTROLLER (4-TUBE SYSTEM)</p>
		
<p>RATIO CONTROL SYSTEM IN WHICH THE SET POINT OF A FLOW CONTROLLER IS ADJUSTED (VIA A RATIO RELAY) BY THE REFERENCE FLOW. BOTH FLOWS BEING RECORDED.</p>		

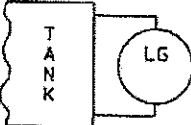
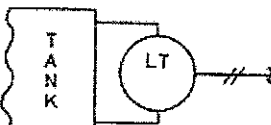
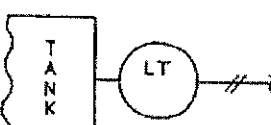
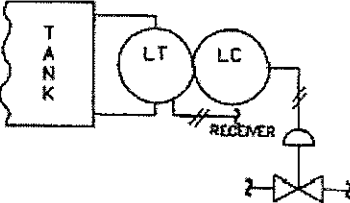
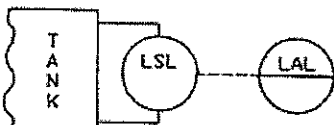
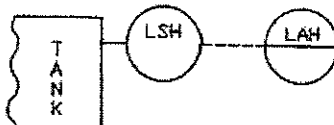
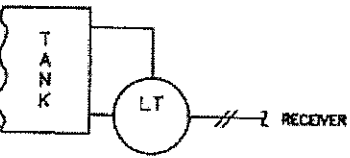
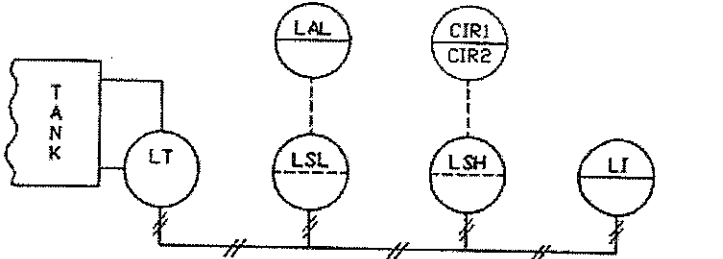
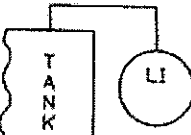
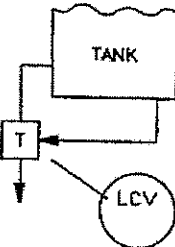
		
<p>GAUGE CLASS EXTERNALLY CONNECTED</p>	<p>EXTERNAL FLOAT OR DISPLACER TYPE LEVEL TRANSMITTER</p>	<p>INTERNAL FLOAT OR DISPLACER TYPE LEVEL TRANSMITTER</p>
		
<p>DUPLEX LEVEL TRANSMITTER CONTROLLER EXTERNAL FLOAT OR DISPLACER TYPE</p>	<p>EXTERNAL FLOAT TYPE LOW LEVEL ALARM SWITCH CONNECTED TO BOARD MOUNTED ANNUNCIATOR</p>	<p>INTERNAL FLOAT TYPE HIGH LEVEL ALARM SWITCH CONNECTED TO BOARD MOUNTED ANNUNCIATOR</p>
		
<p>FLANGE MOUNTED DIFFERENTIAL PRESSURE TYPE LEVEL TRANSMITTER</p>	<p>REMOTE MOUNTED DIFFERENTIAL PRESSURE TYPE LEVEL TRANSMITTER CONNECTED TO BOARD MTD. INDICATOR &amp; REAR MTD. ALARM SWITCHES ACTUATING BOARD MOUNTED ANNUNCIATOR</p>	
		
<p>FLOAT CONNECTED TO GAUGE BOARD OR TAPE IND</p>	<p>CONTINUOUS DRAINER BALL FLOAT TYPE TRAP WITH EQUALIZING CONNECTION</p>	

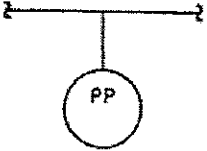
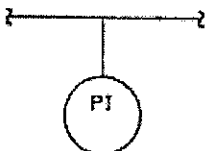
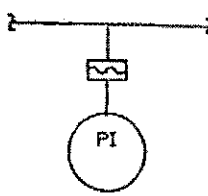
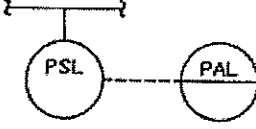
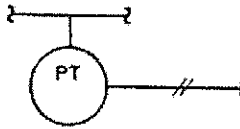
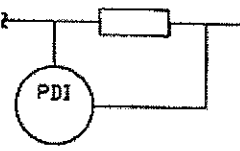
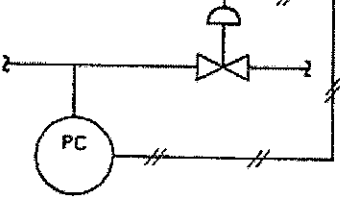
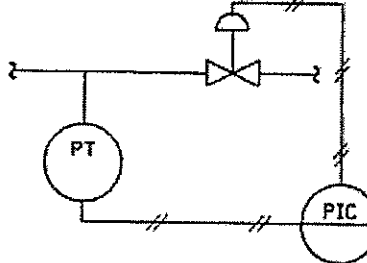
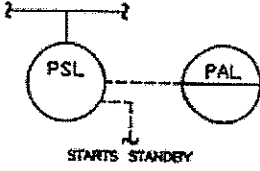
		
<p>PRESSURE CONNECTION WITH PROCESS CONNECTION BLOCK VALVE AND INSTRUMENT BLEED ONLY (TEST POINT)</p>	<p>LOCAL PRESSURE INDICATOR (INCLUDES PRESSURE VACUUM AND DRAFT)</p>	<p>LOCAL PRESSURE INDICATOR WITH CHEMICAL SEAL</p>
		
<p>LOCALLY MOUNTED LOW PRESSURE ALARM SWITCH CONNECTED TO BOARD MTD. ANNUNCIATOR</p>	<p>PRESSURE TRANSMITTER (INCLUDES PRESSURE VACUUM &amp; DRAFT). IF ABSOLUTE IDENTIFY OUTSIDE BALLOON</p>	<p>DIFFERENTIAL PRESSURE INDICATOR</p>
		
<p>LOCAL PRESSURE CONTROLLER BLIND TYPE, PILOT OPERATED</p>	<p>PRESSURE TRANSMITTER CONNECTED TO BOARD MTD. INDICATING CONTROLLER</p>	<p>LOW PRESSURE SWITCH WITH TWO OUTPUTS OPERATING AT SAME TIME FOR ALARM AND CONTROL</p>

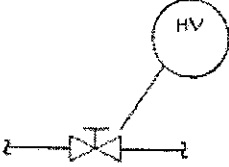
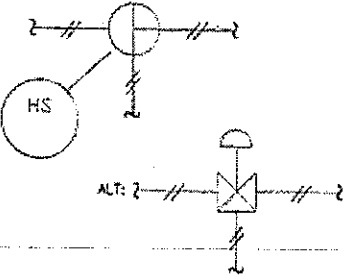
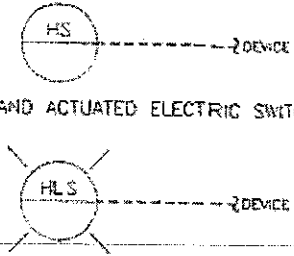
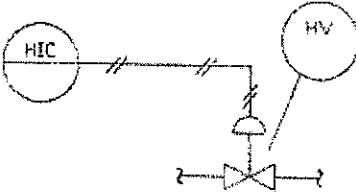
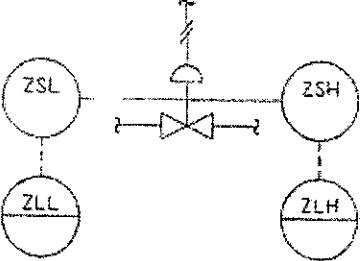
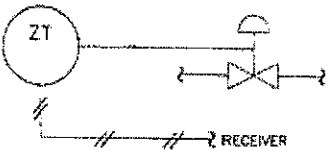
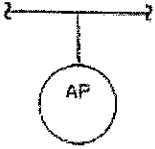
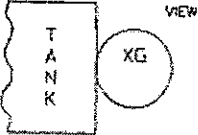
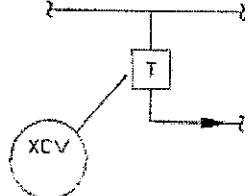
		
<p>HAND CONTROL VALVE IN PROCESS LINE</p>	<p>HAND ACTUATED SWITCHING VALVE IN PNEUMATIC SIGNAL LINE</p>	<p>HAND ACTUATED ELECTRIC SWITCH WITH PILOT LIGHT</p>
		
<p>MANUAL LOADING STATION WITH OUTPUT GAUGE</p>	<p>POSITION SWITCHES CONNECTED TO PILOT LIGHTS INDICATING LOW (OR CLOSED) AND HIGH (OR OPEN) POSITIONS</p>	<p>POSITION TRANSMITTER</p>
		
<p>ANALYSIS TEST SAMPLE POINT</p>	<p>SIGHT GLASS FOR INTERNAL VIEWING</p>	<p>ALL TRAPS OTHER THAN BALL FLOAT TYPE CONTINUOUS DRAINERS</p>

